

Pop-Up Fabric 'Premium' Straight

Delivery specifications

PDF format

- Do not place any cutting lines or frames around the printable image.
- Convert all fonts into letter outlines.
- Remove all invisible layers from the layout.

Use of colour

- Use CMYK colours. No LAB colours.
- For the deepest black, use the following colour codes: CMYK 86/85/79/100 or RGB 0/0/0. When files with both vectors and photos (bitmaps) are used, also use these colour codes in the photos. Otherwise colour differences may arise within the images.

Note: colours can deviate slightly when printed on fabric. A test print is available on special request.

Resolution

- We advise a resolution of 70 to 120 dpi (End format).
(For example: for photos (bitmaps) on a large format canvas for outdoor use, an end resolution of 30 dpi is sufficient. If the image in the file has 10% of the size of the end format, the image in the file must have a resolution of 300 dpi)

Dimensioning

- We always communicate in the sequence width first, then height (w x h).
- Files delivered in the correct ratio (b x h) will automatically be scaled to the requested format.
- Deviations in the ratio (w x h) up to 1.5% are automatically adjusted to the ordered size.
- If the deviation exceeds 1.5%, we will contact you
- Image dimensions can deviate slightly due to stretch, shrinkage or the elastic properties of the material.

File set-up



Important text and images should be placed **within the orange line**. The distance to the orange line is **7 cm**. The seamline of the Velcro will be on the outside of the orange line.

File supply

- Remove all sizes and lines (orange & black).
- Supply in real size in PDF via e-mail / YouSendit / WeTransfer.

Pop-Up Fabric 'Premium' Straight 2x3 (PUFP23S)

Graphical specifications

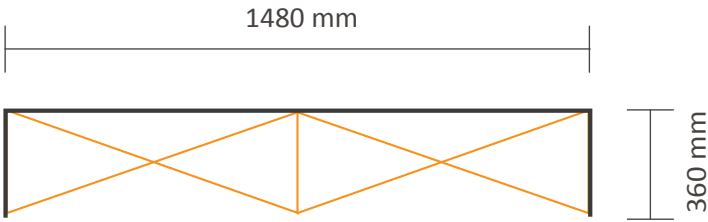

Including visual at left / right side
Actual size of visual: 2200 * 2200 mm (W/H)

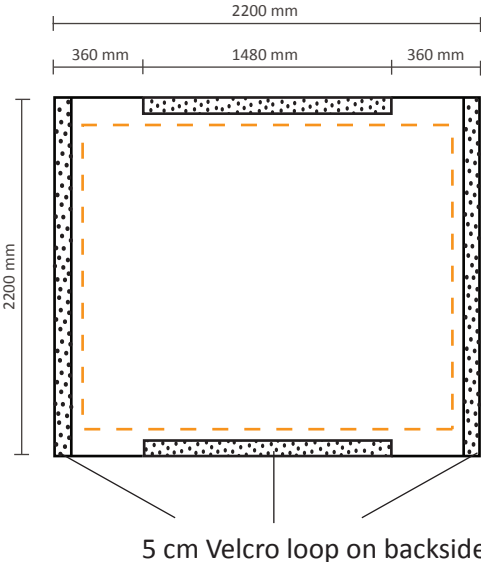

Template for backside

Excluding visual at left / right side
Actual size of visual: 1480 * 2200 mm (W/H)

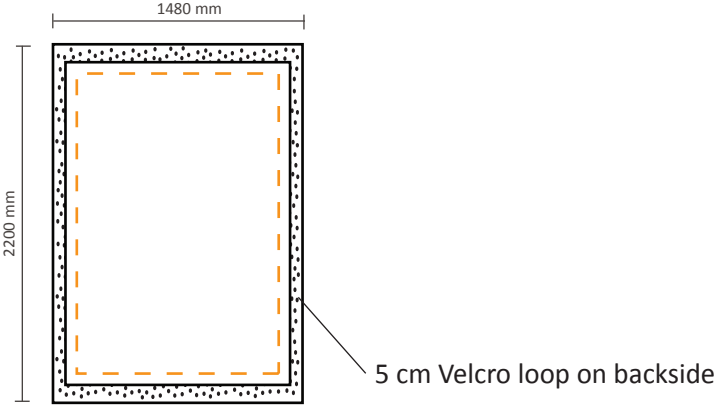

Pop-Up Fabric 'Premium' Straight 3x3 (PUFP33S)

Graphical specifications

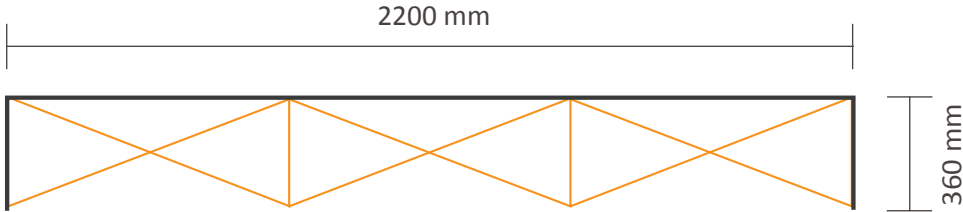

Including visual at left / right side

Actual size of visual: 2920 * 2200 mm (W/H)

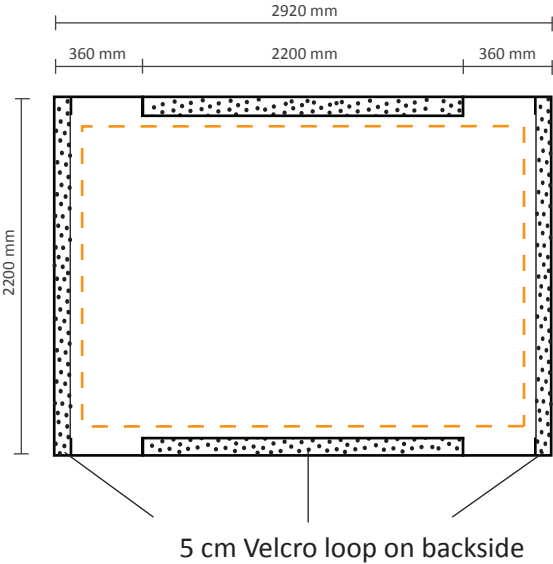

Template for backside

Excluding visual at left / right side

Actual size of visual: 2200 * 2200 mm (W/H)

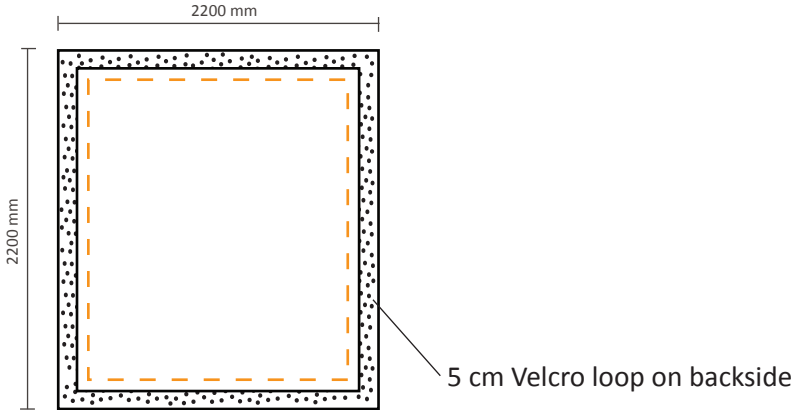

Pop-Up Fabric 'Premium' Straight 4x3 (PUFP43S)

Graphical specifications

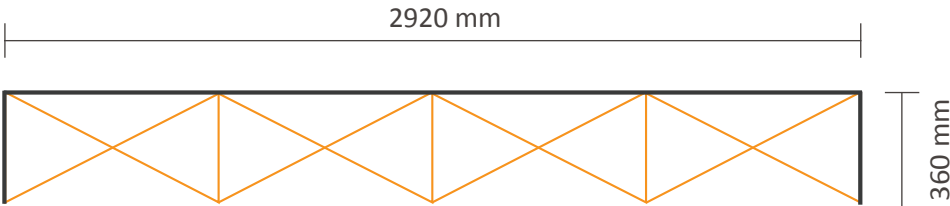

Including visual at left / right side

Actual size of visual: 3640 * 2200 mm (W/H)

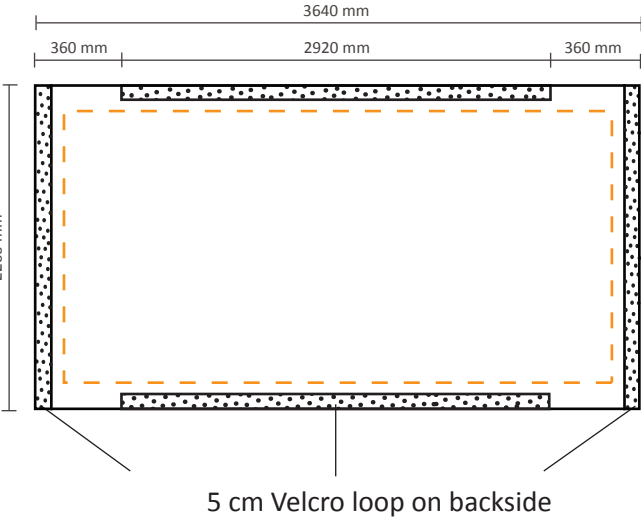

Template for backside

Excluding visual at left / right side

Actual size of visual: 2920 * 2200 mm (W/H)

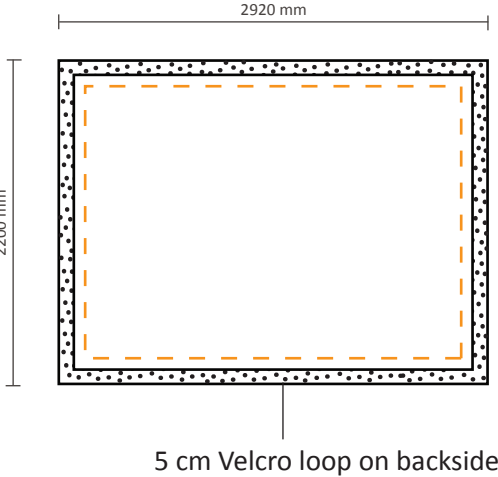

Pop-Up Fabric 'Premium' Straight 5x3 (PUFP53S)

Graphical specifications

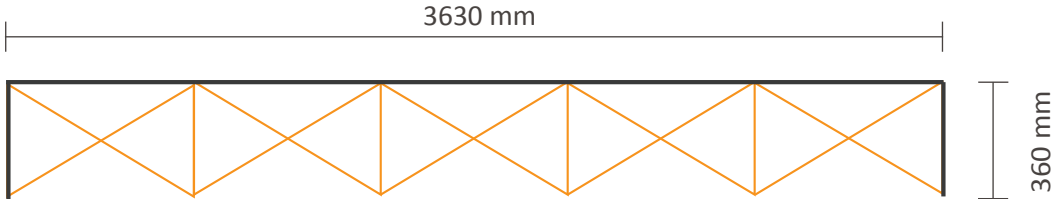

Including visual at left / right side
Actual size of visual: 4350 * 2200mm (W/H)

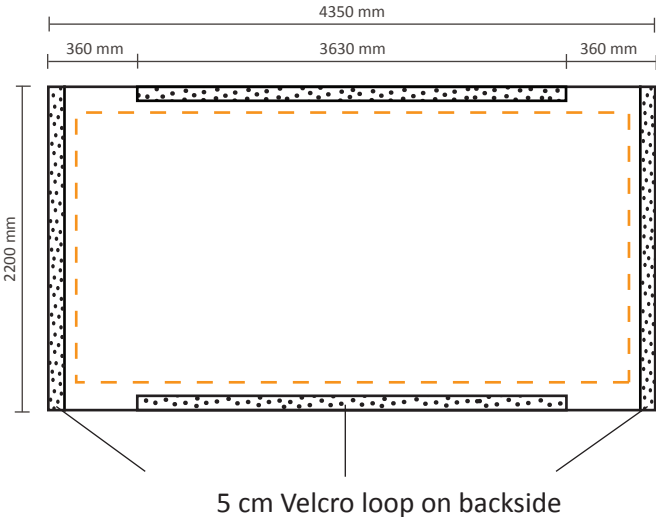

Template for backside

Excluding visual at left / right side
Actual size of visual: 3630 * 2200 mm (W/H)

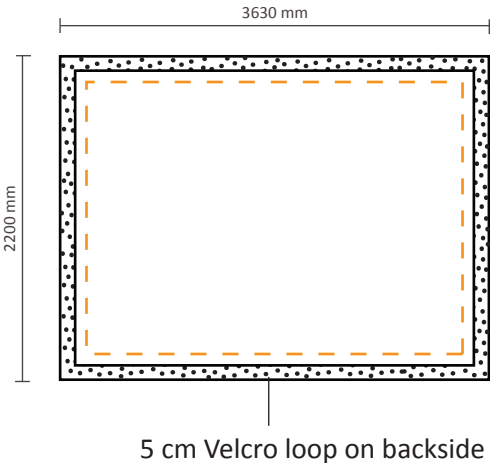

Pop-Up Fabric 'Premium' Straight 2x3 (PUFP23S) with side panels

Graphical specifications

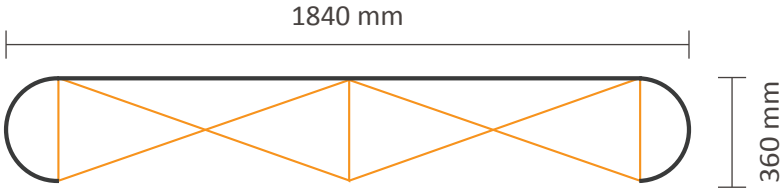

Actual size of visual: 2740 * 2200 mm (W/H)

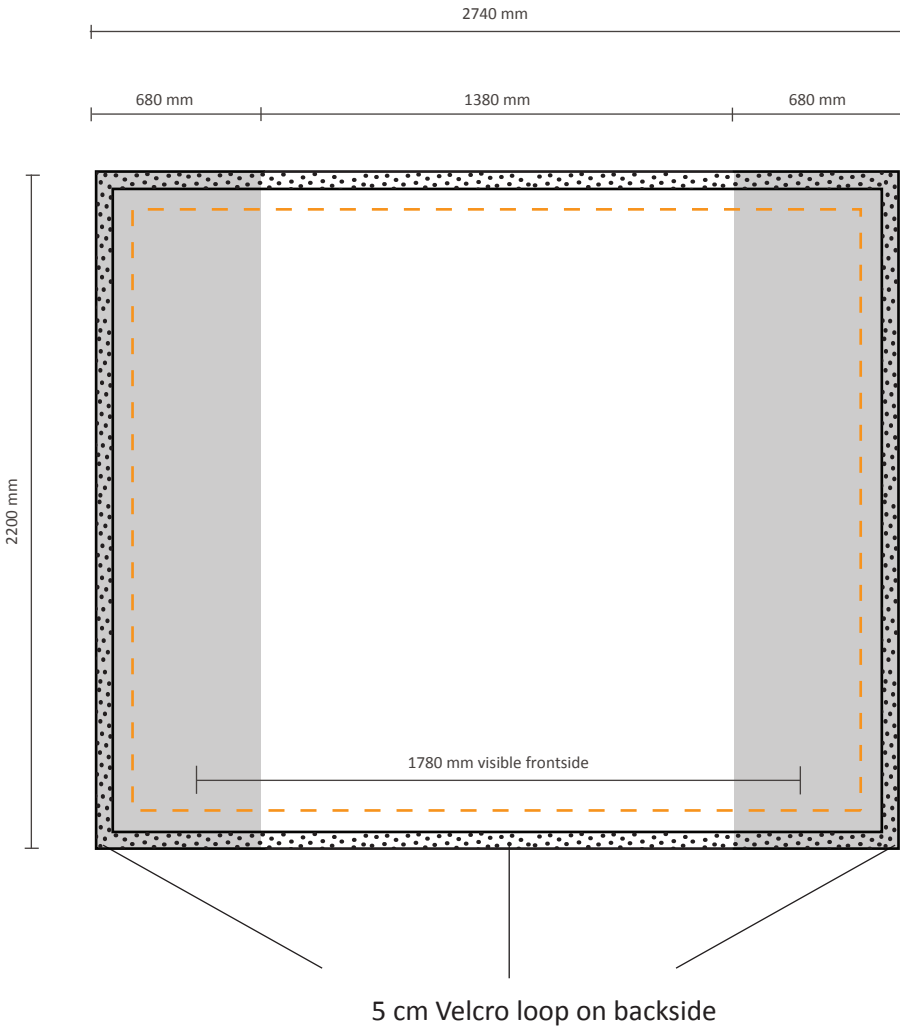

Pop-Up Fabric 'Premium' Straight 3x3 (PUFP33S) with side panels

Graphical specifications

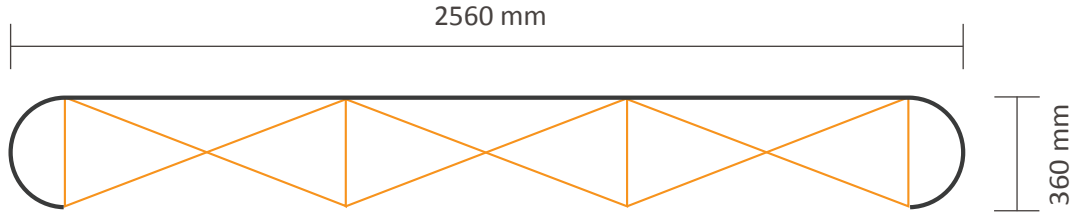

Actual size of visual: 3460 * 2200 mm (W/H)

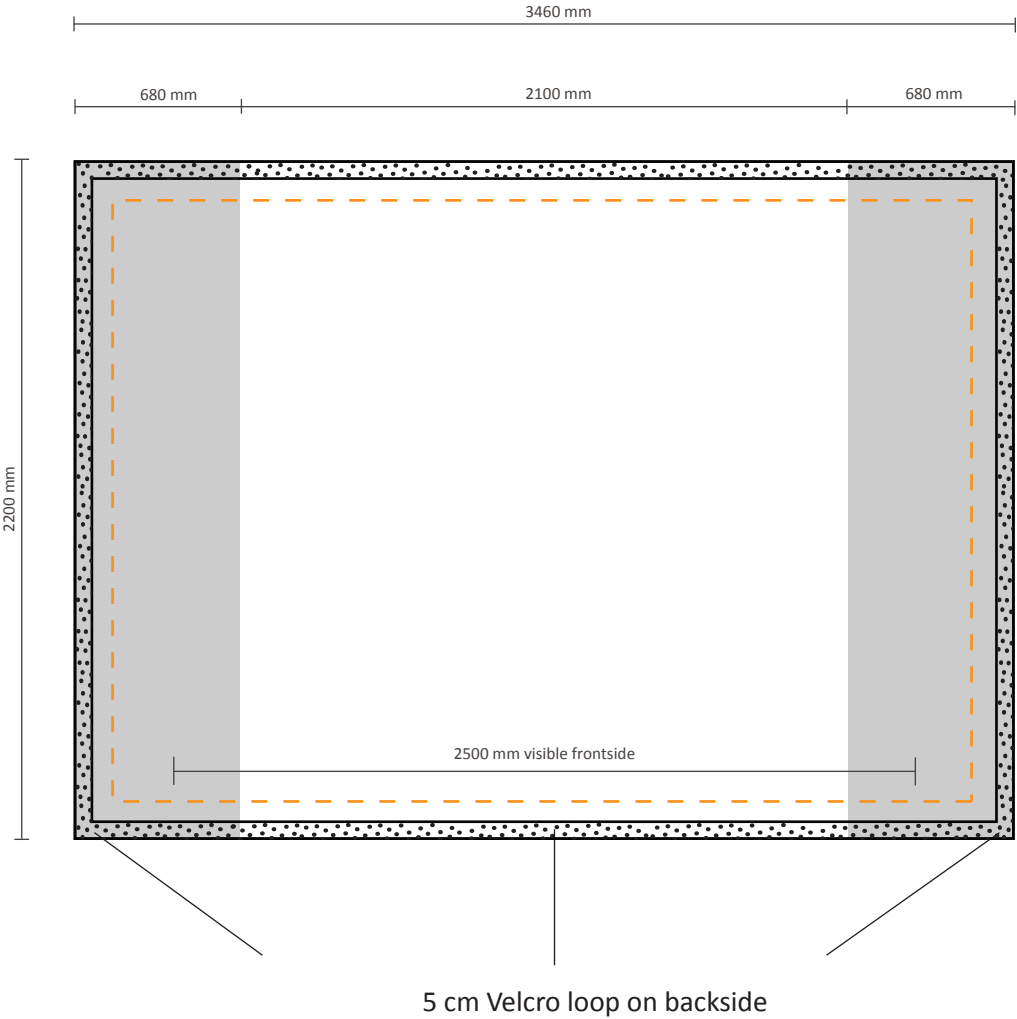

Pop-Up Fabric 'Premium' Straight 4x3 (PUFP43S) with side panels

Graphical specifications

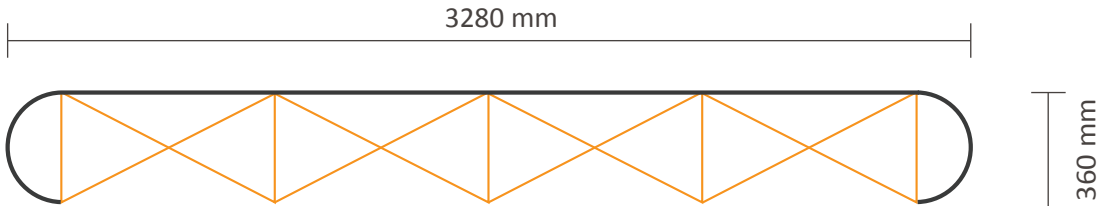

Actual size of visual: 4180 * 2200 mm (W/H)

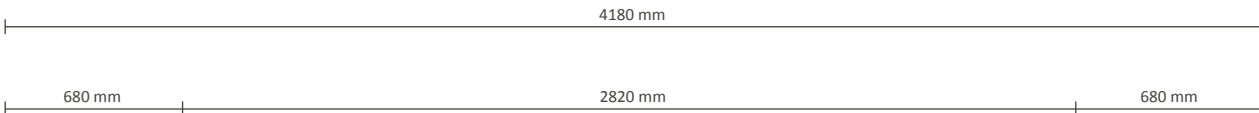

5 cm Velcro loop on backside

Pop-Up Fabric 'Premium' Straight 5x3 (PUFP53S) with side panels

Graphical specifications

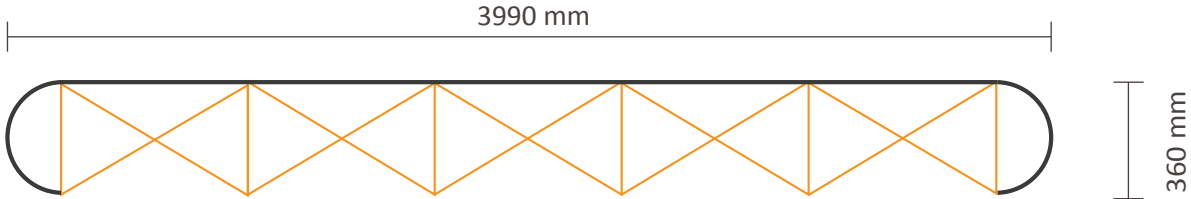

Actual size of visual: 4890 * 2200mm (W/H)

